

EPL type batteries are made in AGM technology and are constructed by plates, separators, safety valves and a container. Since the electrolyte is held by a glass-mat separator and plates, the batteries can be used in any chosen position without the risk of leakage. EPL type batteries have a pressure relief valves that allows safe dispersal of any excess pressure inside the cell (VRLA). EPL batteries are characterized by a longer design life which, according to Eurobat, is 12+ years. Due to their advantages such as being well sealed, maintenance free and having a low internal resistance and long term storage, EPL batteries have been chosen for the base of emergency power supplying.



TECHNICAL DATA

Nominal voltage	12 V	
Nominal capacity	110 Ah / C ₂₀	
Cell per unit	6	
Technology	AGM	
Design life	over 12 years @ 20°C* 10 years @ 25°C	
Dimensions	height	239,0 mm
	length	407,0 mm
	width	173,0 mm
Weight	~40,0 kg	
	Capacity @ 25°C	110,0 Ah
Capacity @ 25°C	20h 5,5A @1,75V/cell	104,5 Ah
	10h 10,45A @1,75V/cell	93,80 Ah
	5h 18,76A @1,75V/cell	69,23 Ah
	1h 69,23A @1,50V/cell	
Ambient nominal temperature range	charge	0°C ~ 40°C
	discharge	-20°C ~ 50°C
	storage	-20°C ~ 40°C
Internal resistance	@ fully charge battery	≤4 mΩ
Charging voltage @ 20°C	standby use	13,5V to 13,8V (-18 mV/°C)
	cycle use	14,4 V to 15,0V (-24 mV/°C)
Charging current	recommended	11 A
	maximum	33 A
Maximum discharge current (for 5 sec)	800 A	
Capacity retention during storage @ 20°C (self discharge)	after 1 month	97 %
	after 6 months	80 %
	after 12 months	63 %
Container material	standard	ABS UL 94-HB
	optional	ABS UL 94-V0**
Terminal	insert terminal	I2
Terminal hardware initial torque	5,5 Nm	

- uninterruptible power supplies (UPS)
- emergency lighting systems
- telecommunication PABX
- cash registers and fiscal printers
- fire and security systems
- marine
- solar powered systems
- golf-carts, wheelchairs
- medical, laboratory equipment
- mobile and portable equipment – cycle use
- measuring devices
- fishing lights

DIMENSIONS

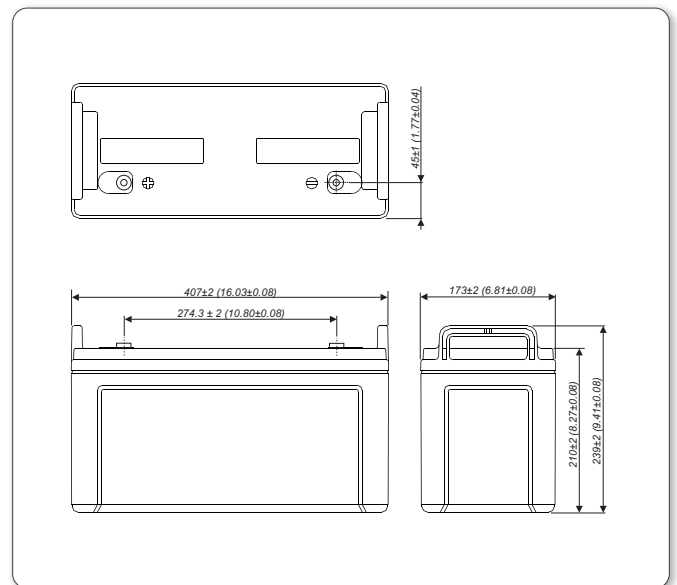

TERMINALS

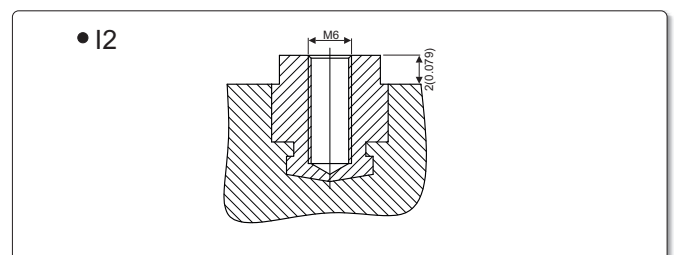

*) - According to Eurobat (Long Life group)

**)- Flame-retardant

NO TRANSPORT RESTRICTED

Not restricted for air, surface and water transport. Classified as non-hazardous material (IATA/ICAO Special Provision A67, DOT-CFR Title 49 parts 171-189, IMDG amendment 27)

DISCHARGE CHARACTERISTICS

• Constant current (Current [A], 25°C / 77°F)

F.V. V/cell	Discharge time										
	5 min	10 min	15 min	30 min	50 min	1hr	2hr	4hr	6hr	8hr	10hr
1,80	299,0	228,5	189,7	111,3	73,40	63,85	34,81	21,46	15,95	12,44	10,29
1,75	352,4	247,5	198,5	115,4	75,40	65,84	35,74	21,87	16,20	12,63	10,45
1,70	374,5	256,5	204,5	118,0	77,19	66,98	36,19	22,08	16,26	12,68	10,51
1,65	391,3	262,6	209,3	119,8	78,20	67,83	36,55	22,15	16,31	12,71	10,53
1,60	404,3	267,9	213,5	120,9	78,84	68,55	36,86	22,21	16,31	12,71	10,53
1,50	420,4	273,2	217,8	122,1	79,62	69,23	37,16	22,28	16,31	12,71	10,53

• Constant power (Power [W/cell], 25°C / 77°F)

F.V. V/cell	Discharge time										
	5 min	10 min	15 min	30 min	50 min	1hr	2hr	4hr	6hr	8hr	10hr
1,80	553,7	432,6	363,5	218,8	145,3	126,7	63,3	42,9	31,9	24,9	20,6
1,75	641,0	468,7	380,5	227,1	150,0	130,4	71,5	43,7	32,4	25,3	20,9
1,70	680,0	485,6	392,1	232,0	152,8	132,8	72,4	44,1	32,5	25,3	21,0
1,65	711,7	497,2	401,2	235,4	154,8	134,6	73,1	44,3	32,6	25,4	21,1
1,60	733,3	507,0	409,1	237,8	156,1	135,9	73,7	44,4	32,6	25,4	21,1
1,50	756,7	516,8	416,3	240,1	157,2	137,0	74,3	44,6	32,6	25,4	21,1

F.V. - Final voltage

Battery life characteristics of standby use

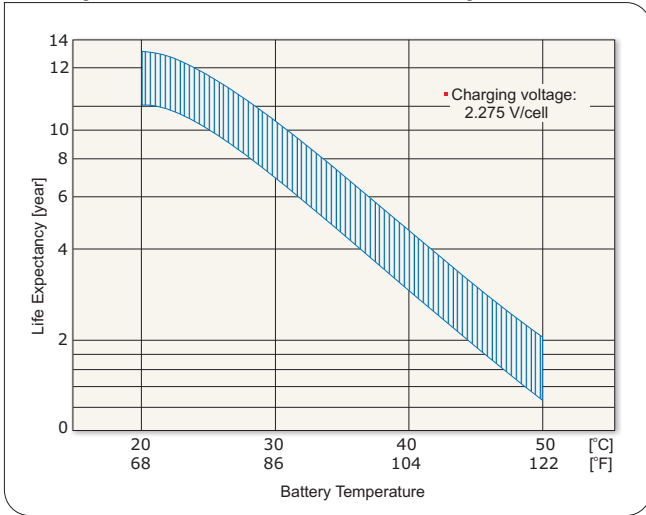

Battery life characteristics of cycle use

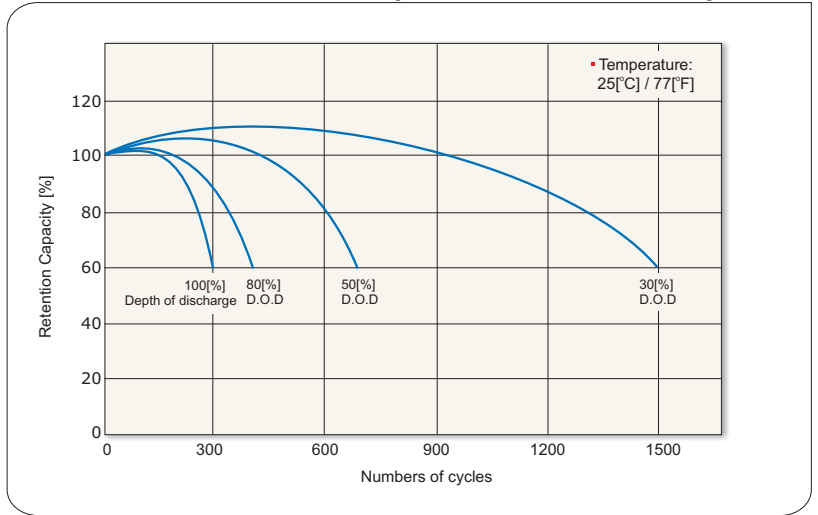

Battery discharge characteristics

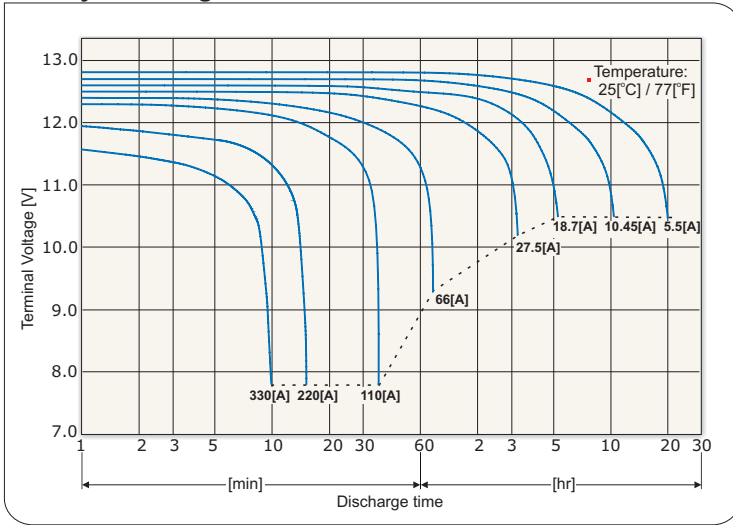

Battery self discharge characteristics

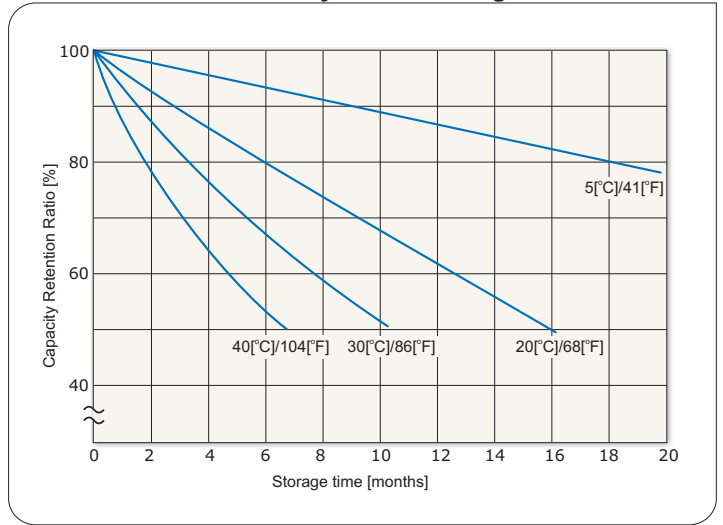

Battery charging characteristics for the standby use

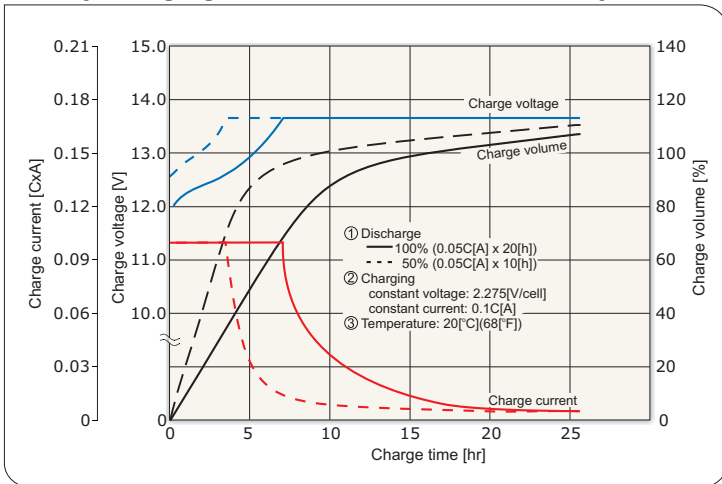

Battery charging characteristics for the cycle use

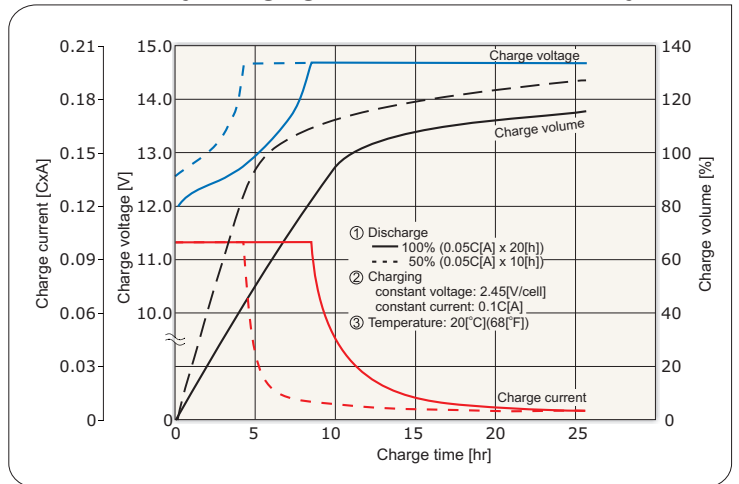

Battery discharge current and final discharge voltage

Discharge current [A]	22 > I	22 ≤ I < 55	55 ≤ I < 110	110 ≤ I
Final discharge voltage [V/cell]	1.75	1.70	1.55	1.30

*) C - Capacity

