

Battery made in **GEL technology** equipped with self-sealing valves which exclude excessive pressure in the cells. Due to large number of cycles and high resistance to deep discharge, EGS series batteries are the best choice for renewable energy systems.

TECHNICAL DATA

Nominal voltage	12 V		
Nominal capacity	120 Ah / C ₁₀₀		
Cell per unit	6		
Technology	GEL		
Design life	10~12 years @ 20°C*		
	8 years @ 25°C		
Dimensions	height	239,0 mm	
	length	407,0 mm	
	width	173,0 mm	
Weight	~39,0 kg		
Capacity @ 25°C	100h	1,20A @1,80V/cell.	120,0 Ah
	20h	5,54A @1,75V/cell.	110,8 Ah
	10h	10,5A @1,75V/cell.	105,0 Ah
	5h	19,8A @1,75V/cell.	99,0 Ah
Ambient nominal temperature range	charge	0°C ~ 40°C	
	discharge	-20°C ~ 50°C	
	storage	-20°C ~ 40°C	
Internal resistance	@ fully charge battery	≤5,0 mΩ	
Charging voltage @ 20°C	standby use	13,5V to 13,8V (-18 mV/°C)	
	cycle use	14,4 V to 15,0V (-24 mV/°C)	
Charging current	recommended	12 A	
	maximum	30 A	
Maximum discharge current (for 5 sec)		800 A	
Capacity retention during storage @ 20°C (self discharge)	after 1 month	97 %	
	after 6 months	79 %	
	after 12 months	60 %	
Container material	standard	ABS UL 94-HB	
	optional	ABS UL 94-V0**	
Terminal	insert terminal	I2	
Terminal hardware initial torque		5,5 Nm	

*)- According to Eurobat (High Performance group) **)- Flame-retardant

NO TRANSPORT RESTRICTED

Not restricted for air, surface and water transport. Classified as non-hazardous material (IATA/ICAO Special Provision A67, DOT-CFR Title 49 parts 171-189, IMDG amendment 27)

DISCHARGE CHARACTERISTICS

• Constant current (Current [A], 25[°C] / 77[°F])

F.V. V/cell	Discharge time										
	1h	2h	3h	4h	5h	6h	8h	10h	20h	100h	120h
1,85	61,5	34,6	26,9	21,3	19,1	16,13	12,21	10,12	5,33	1,171	0,983
1,80	64,6	35,5	27,7	21,8	19,5	16,51	12,51	10,37	5,46	1,200	1,007
1,75	66,6	36,0	28,3	22,2	19,8	16,76	12,69	10,52	5,54	1,218	1,022
1,70	68,0	36,3	28,6	22,3	20,0	16,90	12,80	10,61	5,58	1,228	1,030
1,65	68,8	36,4	28,9	22,4	20,1	16,96	12,83	10,64	5,60	1,232	1,033

• Constant power (Power [W/cell], 25[°C] / 77[°F])

F.V. V/cell	Discharge time										
	1h	2h	3h	4h	5h	6h	8h	10h	20h	100h	120h
1,85	121,0	69,3	53,7	42,6	38,2	32,3	24,4	20,2	10,66	2,34	1,97
1,80	126,3	70,9	55,2	43,6	38,9	32,9	25,0	20,7	10,91	2,40	2,01
1,75	130,2	72,0	56,3	44,3	39,5	33,4	25,4	21,1	11,08	2,44	2,05
1,70	132,8	72,6	57,0	44,7	39,9	33,7	25,6	21,2	11,16	2,46	2,06
1,65	134,5	72,8	57,4	44,8	40,0	33,8	25,7	21,3	11,20	2,46	2,07

F.V. - Final voltage

APPLICATIONS

- Uninterruptible Power Supplies (UPS)
- emergency lighting systems
- street lights
- telecommunication power plants
- telecommunication PBAX
- cable television
- renewable energy systems
- equipment driven by electric motors
- marine
- medical equipment

DIMENSIONS

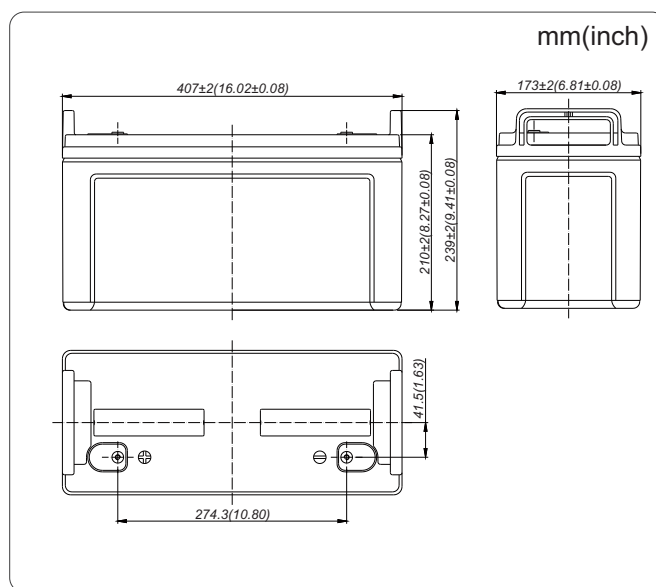

TERMINALS

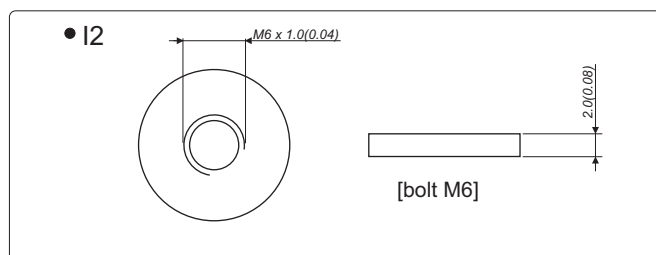

Battery life characteristics of standby use

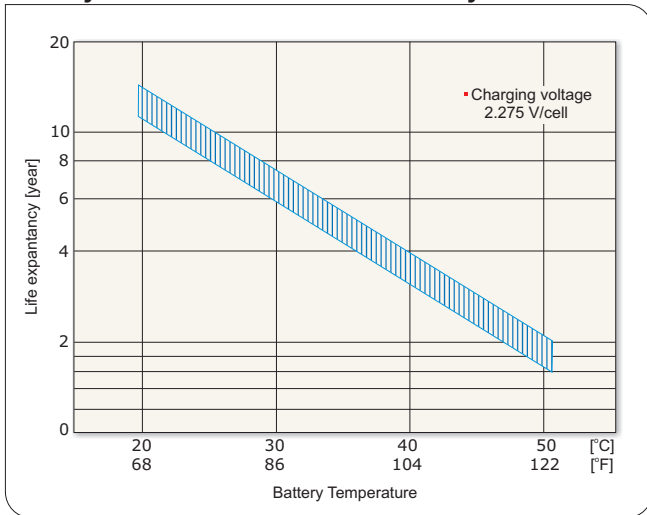

Battery life characteristics of cycle use

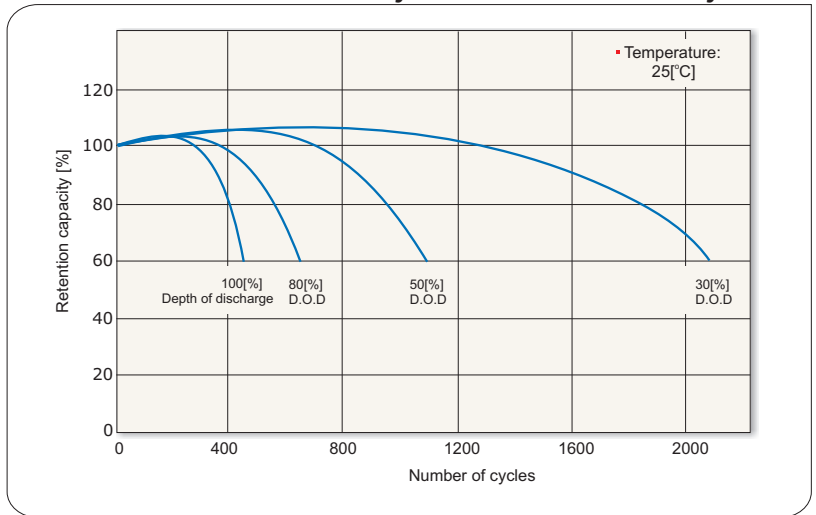

Battery discharge characteristics

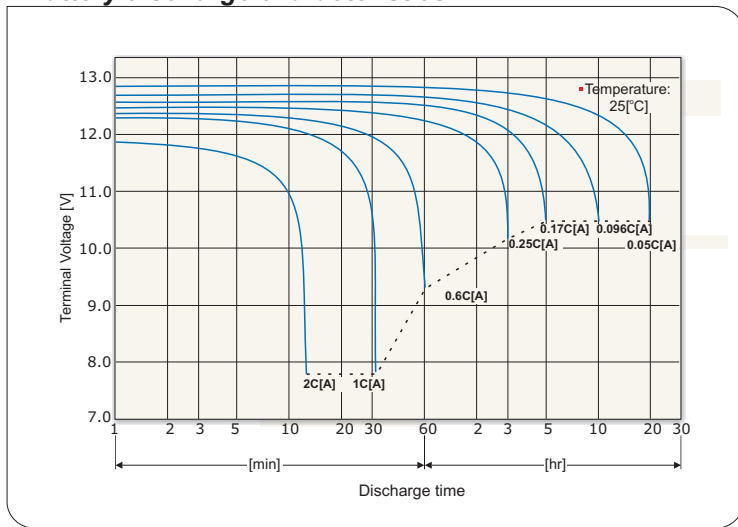

Battery self discharge characteristics

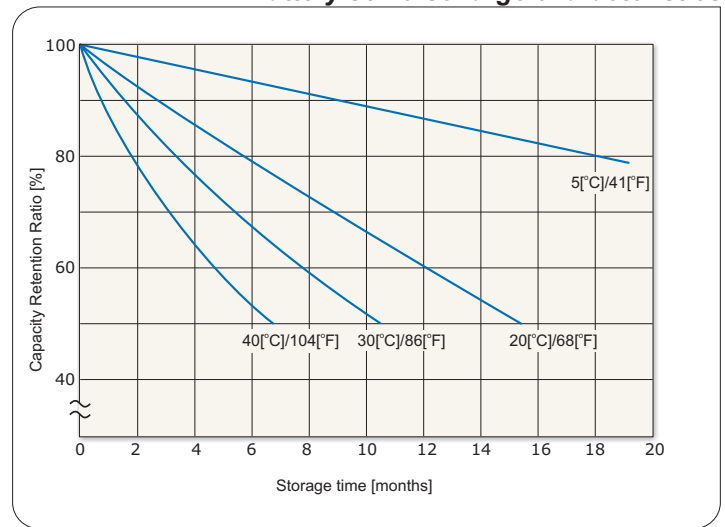

Battery charging characteristics for the standby use

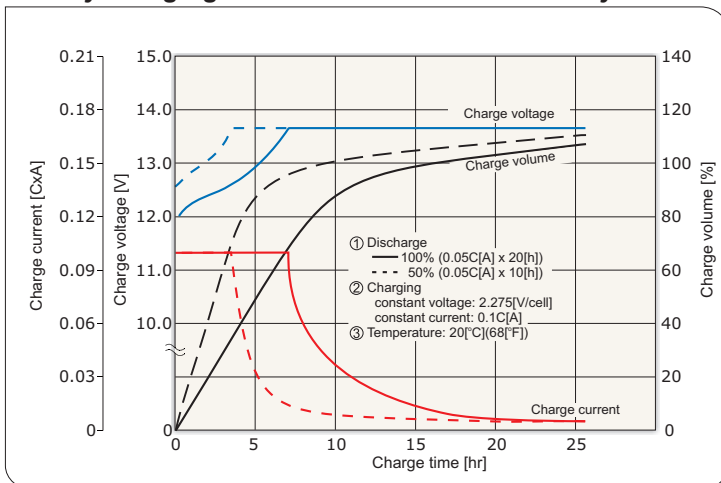

Battery charging characteristics for the cycle use

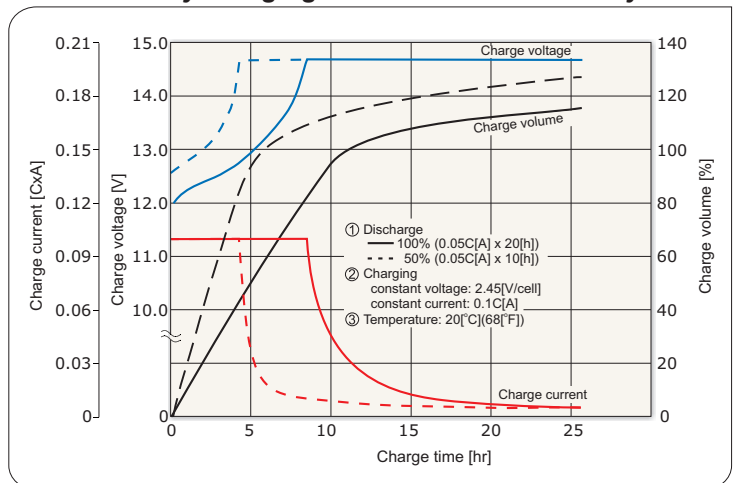

Battery discharge current and final discharge voltage

Discharge current [A]	0.2C > I	0.2C ≤ I < 0.5C	0.5C ≤ I < 1.0C	1.0C ≤ I
Final discharge voltage [V/cell]	1.75	1.70	1.55	1.30

*) C - Capacity

